

**nabatei**

updated to 27-01-2025



**antoniolupi**

# NABATEI

2024

design\_AL Studio

Scultorei e monumentali pur nella loro essenzialità, scolpiti nella pietra come l'antica città di Petra, portatori di un valore di bellezza assoluta e senza tempo che è intrinseca nell'esclusività del marmo e si esprime grazie al progetto dell'uomo. La collezione di lavabi Nabatei, che porta il nome del popolo di commercianti dell'Arabia antica, è composta da una serie di top in massello di marmo scavati per formare il bacino del lavabo e i vani portaoggetti. Vasche di diversa forma e dimensione, disegnate da linee geometriche ortogonali definite da spessori sottili della materia. Un segno essenziale che viene esaltato dall'unicità della pietra, dalle infinite sfumature cromatiche, dalle variazioni irripetibili di colore. Un rimando esplicito alla natura e alla volontà dell'uomo di governarla. La visione zenitale dei top rimanda all'immagine di terreni suddivisi in appezzamenti coltivati, delimitati dai muretti a secco siciliani o dai cambi di quota dei terrazzamenti orientali.

Le differenti porzioni del top separate dai bordi interni possono ospitare la rubinetteria, contenere oggetti e accessori per l'igiene quotidiana oppure assumere la funzione primaria di bacino del lavabo, identificabile con un piccolo foro dal quale far defluire l'acqua.

Ai lavabi/contenitori sono abbinati una serie di mobili sospesi o da terra, dall'estetica essenziale e rigorosa che assecondano quell'idea di leggerezza e senso della misura che è nel dna della collezione. Nascono così composizioni diverse e configurazioni che interpretano le esigenze specifiche dell'area lavabo di ogni progetto, anche grazie alla possibilità di unire più blocchi attraverso un elemento di raccordo che assicura la continuità degli elementi affiancandoli senza interruzioni.

*Sculptural and monumental even in their essentiality, carved in stone like the ancient city of Petra, bearers of a value of absolute and timeless beauty that is inherent in the exclusivity of marble and expressed through human design. The Nabatei sinks collection, named after the merchant people of ancient Arabia, consists of a series of solid marble tops carved to form the basin of the sinks and storage compartments. Sinks of different shapes and sizes, drawn by orthogonal geometric lines defined by thin thicknesses of the material. An essential sign that is enhanced by the uniqueness of the stone, the infinite chromatic shades, the unrepeatably variations of color. An explicit reference to nature and man's willingness to govern it. The zenithal view of the tops reminds of the image of land divided into cultivated plots and bordered by Sicilian dry-stone walls or the elevation changes of eastern cultivated terraces.*

*The different portions of the top separated by the inner edges can house the taps, store objects and accessories for daily use, or take on the primary function of a basin for the washbasin, identifiable by a small hole from which to drain water.*

*The top with sinks and storage spaces are combined with a series of wall-hung or floor-standing cabinets with essential and rigorous aesthetics that go along with that idea of lightness and sense of measure that is in the collection's DNA. Thus, are born different designs and configurations that interpret the specific needs of the washbasin area of each project, also thanks to the possibility of joining several blocks through a connecting element that ensures the continuity of the configuration by placing them side by side without interruption.*











Antonius

NABATEI







NABATEI



ART. NBTB4054 / ART. NBTB4754

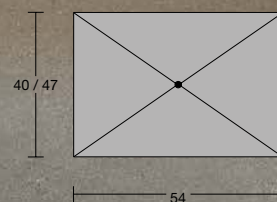



ART. NBTB4072 / ART. NBTB4772

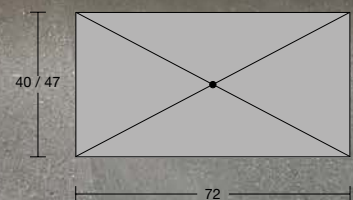

NABATEI





In questa composizione la collezione Nabatei, di misura complessiva L 409,5 cm P 49 cm H 42,5 cm, ha struttura in Skin cenere e ante in Rovere Grigio. Partendo da sinistra, il primo mobile, si compone di due porta lavabi art. NBLB2108 e art. NBLB2108T, e del top in marmo Collemandina art. NBT247, L 216 cm P 47 cm H 10 cm, che ospita due lavabi integrati art. NBTB4754 e quattro elementi divisori art. NBD47. Il secondo mobile si compone di una base art. NBBB236T, un porta lavabo art. NBLB272 e una base art. NBBB272. Il top in marmo Collemandina art. NBT247, L 180 cm P 47 cm H 10 cm, ospita un lavabo integrato art. NBTB4772 e due elementi divisori art. NBD47. La rubinetteria della collezione RANDOM\_essentia in finitura Basalto opaco è composta da tre erogatori da piano art. RD111QV e tre comandi progressivi remoti da piano art. RD600RPV. I due mobili sono collegati dal compensatore in marmo Collemandina art. NBCB47. La composizione si completa di retroilluminazione art. STREETLED.

*Nabatei collection, measuring L 409,5 D 49 H 42,5 cm, has the structure in skin cenere and fronts in Rovere Grigio. From the left the first composition has two sink units art. NBLB2108 and art. NBLB2108T, and top in marble Collemandina art. NBT247, L 216 D 47 H 10 cm with two integrated sinks art. NBTB4754 and four dividers art. NBD47. The second composition is made up of a cabinet art. NBBB236T, a sink unit art. NBLB272 and a cabinet art. NBBB272. the top is in marble Collemandina art. NBT247, L 180 D 47 H 10 cm with an integrated sink art. NBTB4772 and two dividers art. NBD47. The taps are from the RANDOM\_essentia collection in Basalto color, made up of three spouts art. RD111QV and three progressive handles art. RD600RPV. The two compositions are connected with a filler in marble Collemandina art. NBCB47. The composition are completed with back lighting art. STREETLED.*





















Nell'immagine la collezione Nabatei, di misura complessiva L 282,5 cm P 49 cm H 42,5 cm, ha struttura in Skin cenere e ante verniciate Basalto seta. Partendo da sinistra, il primo mobile, si compone di un porta lavabo e una base con frontale unico (su richiesta), e del top in marmo Nero Marquinia art. NBT147, L 144 cm P 47 cm H 10 cm, che ospita un lavabo integrato art. NBTB4772 e un elemento divisorio art. NBD47. Il secondo mobile si compone di una base, un porta lavabo e una base con frontale unico (su richiesta). Il top in marmo Nero Marquinia art. NBT147, L 126 cm P 47 cm H 10 cm, ospita un lavabo integrato art. NBTB4754 e due elementi divisori art. NBD47. La rubinetteria tre fori da piano della collezione RANDOM\_essentia in finitura Nero opaco è art. RD432V.

I due mobili sono collegati dal compensatore in marmo Nero Marquinia art. NBCB47. La composizione si completa di illuminazione interna art. LED\_IN e attrezzatura Strato. A parete la boiserie MARULA\_WOOD art. MRWOOD è in legno Rovere Grigio e ospita lo specchio retroilluminato Circus art. CIRCUS140W, Ø140 cm.

A sinistra box doccia art. COMBI180 versione destra in vetro fumè, H 220 cm completo di profili e asta in acciaio verniciati Nero gofrato. Piatto doccia in Flumood Bianco art. SM\_COMBI80, L 149 cm, P 80 cm. Rubinetteria Mayday art. MAYDAYD, deviatore in Acciaio Satinato e art. MAYDAY, miscelatore in finitura Grafite, doccetta in finitura Grafite e flessibile in silicone Nero art. FILTRO. I soffioni LAMATTONELLA sono gli art. LMN\_2A e art. LMN3\_A; i faretto sono due art. ZENITLED.

A parete termoarredo BITLIGHT art. BITL180E completo di un art. GANCIOLIGHT, il tutto in finitura Skin cenere; illuminazione ad incasso art. SCRIGNO.

La composizione viene completata dal wc sospeso, appartenente alla collezione KOMODO, art. KOMODO3 in finitura satinata, dalla placca ONDA in finitura Grafite e dalla colonna a giorno incassata, in finitura Skin cenere, art. DIMEZZO.



In the picture, the Nabatei collection, with overall dimensions L 282.5 cm D 49 cm H 42.5 cm, has a Skin cenere frame and Basalto silk lacquered doors. Starting from the left, the first cabinet, consists of a sink unit and a cabinet with a single front (upon request), and a Nero Marquinia marble top art. NBT147, L 144 cm D 47 cm H 10 cm, which houses an integrated sink art. NBTB4772 and a dividing element art. NBD47. The second cabinet consists of a cabinet, a sink unit and a cabinet with a single front (upon request). The Nero Marquinia marble top art. NBT147, L 126 cm D 47 cm H 10 cm, houses an integrated sink art. NBTB4754 and two dividing elements art. NBD47. The three-hole countertop faucet from the RANDOM\_essentia collection in matt black finish is art. RD432V. The two pieces of furniture are connected by the Nero Marquinia marble compensator art. NBCB47. The composition is completed with interior lighting art. LED\_IN and Strato equipment. On the wall, the MARULA\_WOOD paneling art. MRWOOD is in Grey Oak wood and houses the Circus backlit mirror art. CIRCUS140W, Ø140 cm. Left shower enclosure art. COMBI180 right version in smoked glass, H 220 cm complete with black embossed lacquered profiles and rod. White Flumood shower tray art. SM\_COMBI80, W 149 cm, D 80 cm. Mayday tap art. MAYDAYD, diverter in Satin Steel and art. MAYDAY, mixer in Graphite finish, hand shower in Graphite finish and Black silicone flexible hose art. FILTRO. The LAMATTONELLA shower heads are art. LMN\_2A and art. LMN3\_A; the spotlights are two art. ZENITLED. Wall-mounted BITLIGHT radiator art. BITL180E complete with an art. GANCIOLIGHT, all in embossed skin cenere finish; recessed lighting art. SCRIGNO. The composition is completed by the wall-hung toilet, belonging to the KOMODO collection, art. KOMODO3 in a satin finish, the ONDA plate in a Graphite finish and the recessed open column, in Skin cenere, art. DIMEZZO.

NABATEI



In questa composizione la collezione Nabatei è presentata sia nella versione sospesa che da terra, entrambe hanno struttura Skin cenere e ante verniciate Basalto seta. Partendo da sinistra il mobile sospeso, L 148 cm P 49 cm H 42,5 cm, si compone di un porta lavabo, art. NBLB2144TT, e del top in marmo Nero Marquinia art. NBT147, L 144 cm P 47 cm H 10 cm, che ospita un lavabo integrato art. NBTB4772 e un elemento divisorio art. NBD47. Il mobile a terra, L 94 cm P 49 cm H 85 cm si compone di un porta lavabo terminale art. NBLA554T e una base art. NBBA836T. Il top in marmo Nero Marquinia art. NBT147, L 90 cm P 47 cm H 10 cm, ospita un lavabo integrato art. NBTB4754 e un elemento divisorio art. NBD47. La rubinetteria della collezione RANDOM\_essentia, uguale per entrambe le composizioni, è in finitura Nero opaco ed è composta da due art. RD432V (rubinetteria 3 fori da piano per lavabo). A parete la boiserie MARULA\_WOOD art. MRWOOD è in legno Rovere Grigio e ospita lo specchio retroilluminato Circus art. CIRCUS140W, Ø140 cm.





*In this composition, the Nabatei collection is presented in both suspended and floor-standing versions, both of which have Skin cenere structures and doors painted Basalto silk. Starting from the left, the suspended cabinet, L 148 cm D 49 cm H 42.5 cm, consists of a sink unit, art. NBLB2144TT, and the Nero Marquina marble top art. NBT147, L 144 cm D 47 cm H 10 cm, which houses an integrated sink art. NBTB4772 and a partition element art. NBD47. The floor-standing cabinet, L 94 cm D 49 cm H 85 cm is consists of an end sink unit art. NBLA554T and a cabinet art. NBBA836T. The Nero Marquina marble top art. NBT147, L 90 cm D 47 cm H 10 cm, houses an integrated sink art. NBTB4754 and a partition element art. NBD47. The tap from the RANDOM\_essentia collection, which is the same for both compositions, is in finish Black matt and consists of two art. RD432V (3-hole countertop taps for sinks).*

*On the wall, the MARULA\_WOOD wall paneling art. MRWOOD is in Rovere Grigio wood and houses the Circus mirror art. CIRCUS140W, Ø140 cm.*

NABATEI



















In questa composizione la collezione Nabatei è presentata con struttura Skin cenere e ante verniciate Basalto seta. Il mobile sospeso, L 148 cm P 49 cm H 42,5 cm, si compone di un porta lavabo, art. NBLB2144TT, e del top in Colormood Basalto art. NBT147, L 144 cm P 47 cm H 10 cm, che ospita un lavabo integrato art. NBTB4772 e un elemento divisorio art. NBD47. La rubinetteria della collezione RANDOM\_essentia in finitura Nero opaco è art. RD432V (rubinetteria 3 fori da piano per lavabo). A parete la boiserie MARULA\_WOOD art. MRWOOD è in legno Rovere Grigio e ospita lo specchio retroilluminato Circus art. CIRCUS140W, Ø140 cm.

*Nabatei collection is presented with Skin cenere structure and Basalto silk lacquered doors. The wall-mounted cabinet, L 148 cm D 49 cm H 42.5 cm, consists of a sink unit, art. NBLB2144TT, and the Colormood Basalt top art. NBT147, L 144 cm D 47 cm H 10 cm, which houses an integrated sink art. NBTB4772 and a partition element art. NBD47. The tap from the RANDOM\_essentia collection in Matt Black finish is art. RD432V (3-hole countertop faucet for washbasin). On the wall, the MARULA\_WOOD paneling art. MRWOOD is in Rovere Grigio wood and houses the Circus backlit mirror art. CIRCUS140W, Ø140 cm.*

NABATEI





NABATEI





In questa composizione la collezione Nabatei è presentata con struttura Skin cenere e ante verniciate Basalto seta. Il mobile sospeso, L 166 cm P 42 cm H 39,5 cm, si compone di due porta lavabi, art. NBLB154T e da una base art. NBBB154 e del top in Colormood Basalto art. NBT140, L 162 cm P 40 cm H 10 cm, che ospita due lavabi integrati art. NBTB4045 e due elementi divisori art. NBD40. La rubinetteria della collezione Essentia in finitura Acciaio satinato è art. ES204SA. A parete lo specchio Nastro art. NASTRO75W, L 162 cm H 75 cm. In primo piano la poltrona Lolla con telaio Cromo lucido e tessuto PARACAS-70KV932.

*The suspended cabinet, L 166 cm D 42 cm H 39.5 cm, consists of two sink units, art. NBLB154T and a cabinet art. NBBB154 and the top in Colormood Basalto art. NBT140, L 162 cm D 40 cm H 10 cm, which houses two integrated sinks art. NBTB4045 and two dividing elements art. NBD40. The faucet from the Essentia collection in Satin Steel finish is art. ES204SA. On the wall the Nastro mirror art. NASTRO75W, L 162 cm H 75 cm. In the foreground the Lolla armchair with Polished Chrome frame and PARACAS-70KV932 fabric.*

NABATEI













Nell'immagine la collezione Riquadro, di misura complessiva L 216 cm P 47 cm H 37,5 cm, ha struttura, frontali e cornici in Rovere Grigio. Partendo da sinistra, si compone di una base art. QIBM290, un porta lavabo art. QILM272, una base art. QIBM254, e due fianchi art. QL1. Il top Nabatei con canale posteriore e retroilluminazione, art. NBT247, L 144 cm P 47 cm H 10 cm, è in Colormood Basalto e ospita il lavabo integrato art. NBTB4772 e due elementi divisorii art. NBD47. La rubinetteria da piano della collezione RANDOM\_essentia in finitura Nero opaco è art. RD111QV e art. RD600RV. A parete la mensola OMBRA con illuminazione a led art. OMBRAL, L 180 cm, e portasalviette art. OMBRAPS27 entrambe bianche; specchi della collezione CODICE. Poltrona MissJoelle con telaio in Nichel lucido e tessuto ONEOTA-110KV002. Tappeto della collezione TRAMANDI art. TM304 L 250 cm P 300 cm.



*In the picture, the Riquadro collection, with an overall size of 216 cm L 216 cm D 47 cm H 37.5 cm, has structure, fronts and frames in Rovere Grigio. Starting from the left, it consists of a cabinet art. QIBM290, a sink unit art. QILM272, a cabinet art. QIBM254, and two finished side panels art. QL1. The Nabatei top with back canal and backlighting, art. NBT247, L 144 cm D 47 cm H 10 cm, is in Colormood Basalt and houses the integrated sink art. NBTB4772 and two dividing elements art. NBD47. The countertop faucets from the RANDOM\_essentia collection in Matt Black finish are art. RD111QV and art. RD600RV. On the wall the OMBRA shelf with LED lighting art. OMBRAL, L 180 cm, and towel rack art. OMBRAP27 both white; mirrors from the CODE collection. MissJoelle armchair with polished nickel frame and ONEOTA-110KV002 fabric. Carpet from the TRAMANDI collection art. TM304 L 250 cm D 300 cm.*

NABATEI





Nell'immagine la consolle Nabatei, art. NBTX75, verniciata Nero gofrato, ospita il top Nabatei art. NBT140, L 90 cm P 40 cm H 10 cm in marmo Grigio Lavico con il lavabo integrato art. NBTB4054 e due elementi divisori art. NBD40. La rubinetteria della collezione Essentia in finitura Nero opaco è art. ES204V. A parete pannelli su misura verniciati Basalto, carta da parati Tralerighe art. Q2N e porta salviette art. RETTA472 verniciata Basalto seta.

*Pictured is the Nabatei console, art. NBTX75, lacquered embossed Black, houses the Nabatei top art. NBT140, L 90 cm D 40 cm H 10 cm in Grigio Lavico marble with the integrated sink art. NBTB4054 and two dividers art. NBD40. The taps of the collection Essentia in matt black finish is art. ES204V. The wall panels are custom lacquered Basalto, paper Tralerighe wallpaper art. Q2N and towel holder art. RETTA472 lacquered Basalto silk.*



## NABATEI

**IT** - Basamento in metallo verniciato da utilizzare con top Nabatei. Misura minima 54 cm, misura massima 144 cm.  
**EN** - Painted metal base for use with Nabatei tops. Minimum size 54 cm, maximum size 144 cm.  
**DE** - Lackierter Metallgestell zur Verwendung mit Nabatei- Tops. Mindestmaß 54 cm, Höchstmaß 144 cm.  
**FR** - Support en métal laqué à utiliser avec les tops Nabatei. Taille minimale 54 cm, taille maximale 144 cm.  
**ES** - Base de metal lacado para utilizar con Wencimeras Nabatei. Medida mínima 54 cm, medida máxima 144 cm.  
**RU** - Структура из крашенного металла под столешницу Nabatei. Минимальный размер 54 см, максимальный 144 см.

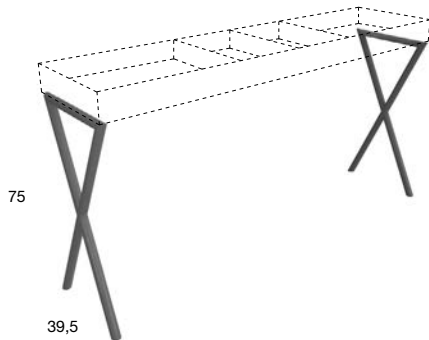

**Bianco o nero gofrato**  
 Embossed lacquered White or black

**Verniciato gofrato**  
 Embossed lacquered

H	L	ART.
75	39,5	NBTX75



## NABATEI

**1**

Ottone lucido  
Cromo lucido  
Polished brass  
Polished chrome

**2**

Ottone satinato, Nero opaco, Bianco opaco  
Acciaio satinato, Grafite  
Satin brass, Matt black, Matt white  
Satin steel, Graphite

BRAGA design AL Studio

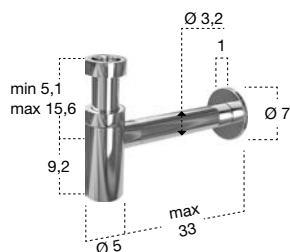
**IT** \_ Sifone in ottone regolabile in altezza per lavabi.**EN** \_ Brass siphon adjustable in height for sinks.**DE** \_ Regulierbarer Siphon aus Messing für Becken.**FR** \_ Siphon réglable en hauteur en laiton pour lavabos.**ES** \_ Sifón en latón regulable en altura para lavabos.**RU** \_ Сифон латунный для раковин, регулируемый по высоте.**1****2****ART.****BRAGA**

MICRO design AL Studio

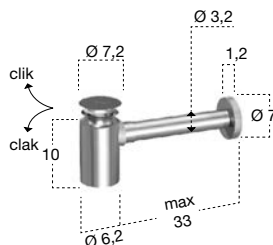
**IT** \_ Sifone in ottone non regolabile in altezza, con piletta in ottone e con sistema di scarico a pressione clik-clak per lavabi e bidet.**EN** \_ Brass siphon for sinks and bidet, not adjustable in height, complete with pressure plug for sinks and bidet.**DE** \_ Nicht regulierbarer Siphon aus Messing, mit Ablaufgarnitur aus Messing und Clik-Clak-System, für Becken und Bidet.**FR** \_ Siphon en laiton non réglable en hauteur complet de bonde en laiton avec vidage manuel clik-clak pour lavabos et bidets.**ES** \_ Sifón de latón no regulable en altura equipado con válvula en latón con sistema a presión clik-clak para lavabos y bidet.**RU** \_ Сифон латунный, для раковин и биде, нерегулируемый по высоте, с донным клапаном нажимного типа из латуни.

Cromo Lucido  
Polished Chrome

Acciaio Satinato  
Satin Stainless Steel

**ART.****MICRO**

NANO design AL Studio

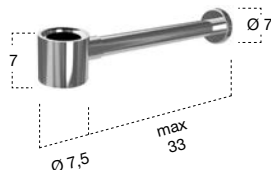
**IT** \_ Sifone compatto in ottone non regolabile in altezza per lavabi.**EN** \_ Compact brass siphon for sinks not adjustable in height.**DE** \_ Kompakter, nicht höhenverstellbarer Siphon aus Messing für Becken.**FR** \_ Siphon compact en laiton non réglable en hauteur pour lavabos.**ES** \_ Sifón compacto de latón para lavabos no regulable en altura.**RU** \_ Компактный латунный сифон нерегулируемый по высоте для раковин.

Cromo Lucido  
Polished Chrome

Nero Opaco  
Matt Black

**ART.****NANO**



NABATEI

- IT** \_ I lavabi integrati delle collezioni Nabatei vengono forniti **DI SERIE** con il Foro a scarico libero (F).  
Su richiesta è possibile scegliere il Copripiletta (C) aggiungendo il codice di riferimento al codice del lavabo integrato.
- EN** \_ The integrated sinks in the Nabatei collections are supplied **AS STANDARD** with the free flow drain Hole (F).  
On request, you can choose the Cover (C) by adding the reference code to the code of the integrated sink.
- DE** \_ Die integrierten Waschbecken der Nabatei-Kollektionen werden **STANDARDMÄSSIG** mit Ablaufbohrung geliefert (F).  
Auf Anfrage ist es möglich, die Abdeckplatte (C) zu wählen, indem man den Referenzcode an den Code des integrierten Waschbeckens anhängt.
- FR** \_ Les lavabos intégrés des collections Nabatei sont fournis **STANDARD** avec le trou à écoulement libre (F).  
Sur demande, il est possible de choisir le bouchon de la bonde (C) en ajoutant le code de référence au code du lavabo intégré.
- ES** \_ Los lavabos integrados de las colecciones Nabatei se suministran **COMO ESTÁNDAR** con el Orificio de desagüe fijo (F).  
Bajo pedido, es posible elegir el Tapón para desagüe (C) añadiendo el código de referencia al código del lavabo integrado.
- RU** \_ Интегрированные раковины коллекции Nabatei поставляются с отверстием свободного слива (F).  
По запросу можно выбрать крышку (C), добавив артикул к артикулу интегрированной раковины.



**F**

- IT** \_ Foro a scarico libero di serie.
- EN** \_ Free flow drain hole as standard.
- DE** \_ Standardvariante mit Ablaufbohrung.
- FR** \_ Trou à écoulement libre standard.
- ES** \_ Orificio de desagüe fijo estándar.
- RU** \_ Отверстие самотечного слива по умолчанию.



**C**

- IT** \_ Piletta in marmo con logo a scarico libero su richiesta.
- EN** \_ Free flowing marble drain with logo upon request.
- DE** \_ Nicht verschließbare Ablaufgarnitur aus Marmor mit LOGO auf Anfrage erhältlich.
- FR** \_ Bonde en marbre avec logo à écoulement libre sur demande.
- ES** \_ Válvula de desagüe fija de mármol con logotipo bajo pedido.
- RU** \_ крышка самотечного донного клапана из мрамора с логотипом по запросу.

ESEMPI ARTICOLI DA ORDINARE - EXAMPLE OF HOW TO ORDER - BEISPIELE ARTIKEL ZUM BESTELLEN - EXEMPLE DES ARTICLES À COMMANDER - EJEMPLOS ARTÍCULOS A PEDIR - ПРИМЕР ОБОЗНАЧЕНИЯ АРТИКУЛОВ ПРИ ЗАКАЗЕ



**1**

art. NBTB4054

+

- IT** \_ Lavabo integrato in marmo.
- EN** \_ Marble integrated sinks.
- DE** \_ Integriertes Waschbecken aus Marmor.
- FR** \_ Lavabo intégré en marbre.
- ES** \_ Lavabo de mármol integrado.
- RU** \_ Интегрированная раковина из мрамора.

**2**

**C**

- IT** \_ Piletta in marmo con logo a scarico libero su richiesta.
- EN** \_ Free flowing marble drain with logo upon request.
- DE** \_ Nicht verschließbare Ablaufgarnitur aus Marmor mit LOGO auf Anfrage erhältlich.
- FR** \_ Bonde en marbre avec logo à écoulement libre sur demande.
- ES** \_ Válvula de desagüe fija de mármol con logotipo bajo pedido.
- RU** \_ крышка самотечного донного клапана из мрамора с логотипом по запросу.

art. NBTB4054 (1) + C (2)

=

art. NBTB4054C

## NABATEI

- IT** - Per calcolare il prezzo completo del top Nabatei (A) con o senza canale, scegliere la misura desiderata e aggiungere:  
**B** la lavorazione dei lavabi da 45, 54 o 72 cm.  
**C** l'elemento divisorio, art. NBT40 o art. NBT47, che servirà necessariamente per delimitare l'area del lavabo integrato o come optional per definire gli spazi di contenimento.
- EN** - To calculate the complete price of Nabatei top (A) with or without channel, choose the desired size and add:  
**B** the processing of the 45, 54 or 72 cm sinks.  
**C** the dividing element, item NBT40 and item NBT47, which will necessarily serve to delimit the area of the integrated washbasin or as an option to define the storage spaces.
- DE** - Um den Gesamtpreis des Nabatei Top(A), mit oder ohne Rückkanal, zu berechnen, wählen Sie das gewünschte Maß und fügen Sie hinzu:  
**B** die Verarbeitung des Waschbeckens 45, 54 oder 72 cm.  
**C** das Trennelement, Art. NBT40 und Art. NBT47, das notwendigerweise dazu dient, das Beckenfläche abzugrenzen oder als Option, um die Ablageflächen zu definieren.
- FR** - Pour calculer le prix complet du plan Nabatei (A) avec ou sans canal postérieur, choisissez la taille souhaitée et ajoutez:  
**B** le lavabo de 45, 54 ou 72 cm.  
**C** l'élément de séparation, art. NBT40 ou art. NBT47, qui servira nécessairement à délimiter la zone du lavabo intégré ou, en option, à définir l'espace de rangement.
- ES** - Para calcular el precio completo de la encimera Nabatei (A) con o sin canal, seleccionar la medida deseada y añadir:  
**B** la elaboración del lavabo de 45, 54 o 72 cm.  
**C** el elemento divisorio, art. NBT40 y art. NBT47, que servirá necesariamente para delimitar el área del lavabo integrado o como opcional para definir los espacios de almacenamiento.
- RU** - Для расчета окончательной стоимости столешницы Nabatei (A) с/без канала необходимо выбрать желаемый размер и добавить:  
**B** раковину на 45, 54 или 72 см;  
**C** разделительный элемент, арт. NBT40 и арт. NBT47, который обязательно будет использоваться для разграничения площади интегрированной раковины или в качестве определения пространства для предметов.

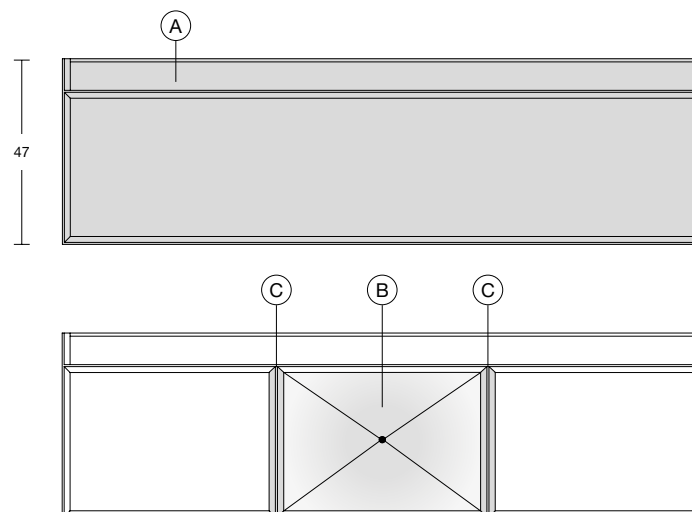
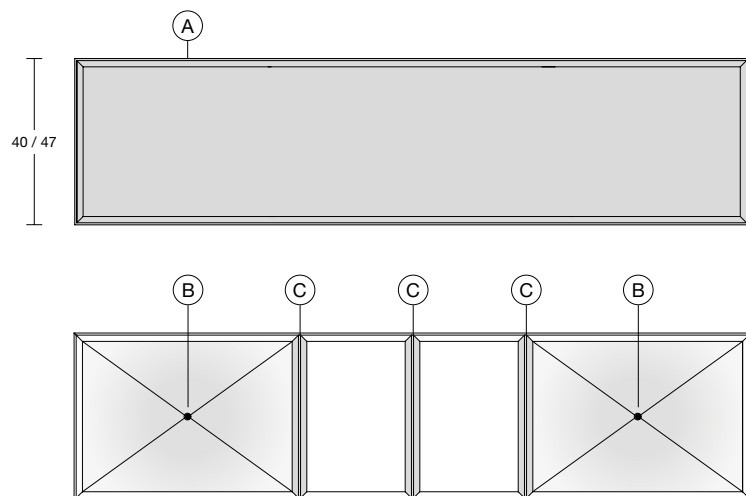

**ESEMPIO TOP CON DOPPIO LAVABO INTEGRATO - EXAMPLE TOP WITH INTEGRATED DOUBLE SINK - BEISPIEL TOP MIT 2 INTEGRIERTEN BECKEN - EXEMPLE DE PLAN AVEC DOUBLE LAVABO INTÉGRÉ - EJEMPLO ENCIMERA CON DOBLE LAVABO INTEGRADO - ПРИМЕР СТОЛЕШНИЦЫ С 2-МЯ ИНТЕГРИРОВАННЫМИ РАКОВИНАМИ**

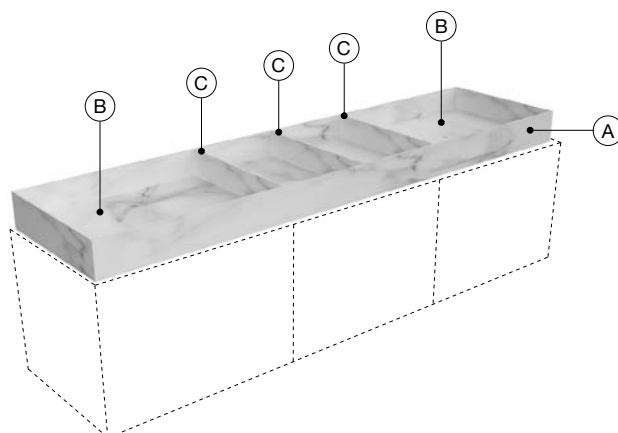
**(A) ART. NBT140**

Top in marmo  
 Marble top  
 Marmor top  
 Plans en marbre  
 Encimera de mármol  
 Столешница из мрамора

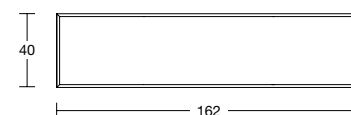

+

**(B) N° 2 ART. NBTB4054**

Lavorazione per lavabo integrato L.54 cm  
 Workmanship for integrated sink L.54 cm  
 Verarbeitung für integriertes Becken L.54 cm  
 Usinage pour lavabo intégré L.54cm  
 Elaboración para lavabo integrado cm. L.54  
 Надбавка за интегрированную раковину шириной 54 см

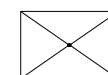

| 54 |

| 54 |

+

**(C) N° 3 ART. NBD40**

Elemento divisorio  
 Partition element  
 Trennelement  
 Élément de séparation  
 Elemento divisorio  
 Разделительный элемент

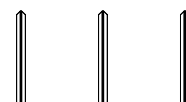

## NABATEI

- 30** IT \_ Lavorazione per lavabo integrato.  
 EN \_ Workmanship for integrated sink.  
 DE \_ Verarbeitung für integriertes Becken.  
 FR \_ Usinage pour lavabo intégré.  
 ES \_ Elaboración para lavabo integrado.  
 RU \_ Надбавка за интегрированную раковину.

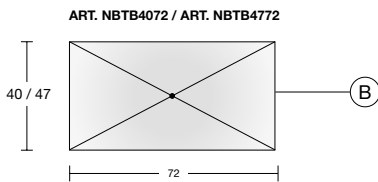
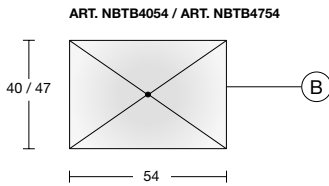
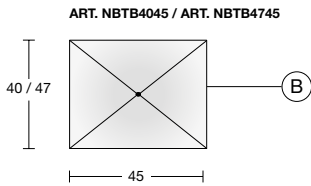

P	L	ART.					Marmo / Pietra Marble / Stone	Colormood
40	45	NBTB4045						
	54	NBTB4054						
	72	NBTB4072						
47	45	NBTB4745						
	54	NBTB4754						
	72	NBTB4772						

- IT \_ Elemento divisorio in marmo, pietra o Colormood.  
 EN \_ Partition element made of marble, stone or Colormood.  
 DE \_ Trennelement aus Marmor, Naturstein oder Colormood.  
 FR \_ Élément de séparation en marbre, pierre ou en Colormood.  
 ES \_ Elemento divisorio de mármol, piedra o Colormood.  
 RU \_ Разделительный элемент из мрамора, камня или Colormood.

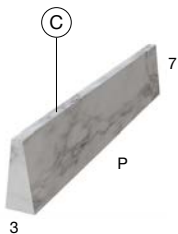

L	H	P	ART.	Bianco Carrara Nero Marquina Stone Grey Bardiglio Nuvolato Pietra Luna Collemandina	Emperador	Grigio Lavico Verde Alpi	Bianco Silver Rosso Levanto	Port Laurent	Calacatta Viola	Colormood
3	7	40	NBD40							
		47	NBD47							

NABATEI

Art. **NBT140** P 40

Art. **NBT147** P 47

IT \_ Top in marmo, pietra o Colormood.

EN \_ Marble, stone or Colormood top.

DE \_ Marmor, Naturstein oder Colormood Top.

FR \_ Plans en marbre, pierre ou en Colormood.

ES \_ Encimera de mármol, piedra o Colormood.

RU \_ Столешница из мрамора, камня или Colormood.

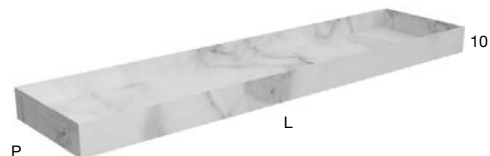

P	L	Bianco Carrara Nero Marquinia Stone Grey Bardiglio Nuvolato Pietra Luna Collemandina	Emperador	Grigio Lavico Verde Alpi	Bianco Silver Rosso Levante	Port Laurent	Calacatta Viola	Colormood
40	54/62							
	63/71							
	72/80							
	81/89							
	90/98							
	99/107							
	108/116							
	117/125							
	126/134							
	135/143							
	144/152							
	153/161							
	162/170							
	171/179							
	180/188							
	189/197							
198/206								
207/216								
47	54/62							
	63/71							
	72/80							
	81/89							
	90/98							
	99/107							
	108/116							
	117/125							
	126/134							
	135/143							
	144/152							
	153/161							
	162/170							
	171/179							
	180/188							
	189/197							
198/206								
207/216								

NABATEI

Art. **NBT247** P 47

**IT** \_ Top in marmo, pietra o Colormood con canale posteriore.

**EN** \_ Marble, stone or Colormood top with back canal.

**DE** \_ Top aus Marmor, Naturstein oder Colormood mit Rückkanal.

**FR** \_ Top en marbre, pierre ou en Colormood avec plage arrière.

**ES** \_ Encimera de mármol, piedra o Colormood con canal trasero.

**RU** \_ Столешница из мрамора, камня или Colormood с бортиками для закрытия.

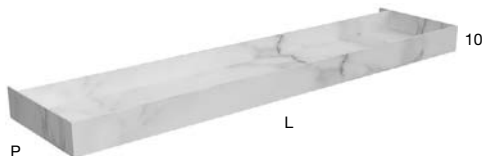

Bianco Carrara  
Nero Marquina  
Stone Grey  
Bardiglio Nuvolato  
Pietra Luna  
Collemandina

Emperador

Grigio Lavico  
Verde Alpi

Bianco Silver  
Rosso Levanto

Port Laurent

Calacatta Viola

Colormood

P	L	Bianco Carrara	Nero Marquina	Stone Grey	Bardiglio Nuvolato	Pietra Luna	Collemandina	Emperador	Grigio Lavico	Verde Alpi	Bianco Silver	Rosso Levanto	Port Laurent	Calacatta Viola	Colormood	
47	54/62															
	63/71															
	72/80															
	81/89															
	90/98															
	99/107															
	108/116															
	117/125															
	126/134															
	135/143															
	144/152															
	153/161															
	162/170															
	171/179															
	180/188															
	189/197															
	198/206															
	207/216															



**IT** \_ Illuminazione a led compresa di trasformatore per top con canale posteriore.

**EN** \_ LED lighting complete with transformer for ltop with back canal.

**DE** \_ Led- Beleuchtung inkl. Transformator für Top mit Rückkanal.

**FR** \_ Éclairage LED avec transformateur pour plans avec canal arrière.

**ES** \_ Iluminación LED incluido transformador para encimeras con canal trasero.

**RU** \_ Светодиодная планка для подсветки столешниц с каналом с тыльной стороны, в комплекте с трансформатором.

da/a-from/to-von/bis-à/et-de/a-от/до

L 54/216 ART. **STREETLED**

NABATEI

**LAVABO DECENTRATO - OFF-CENTER SINK - EXZENTRISCHES BECKEN - LAVABO DÉCENTRÉ - LAVABO DESCENTRADO - ДЕЦЕНТРАЛИЗОВАННАЯ РАКОВИНА**

VERSIONE SX - Left version - Version links - Version gauche  
- Versión izquierda - Лев. вариант

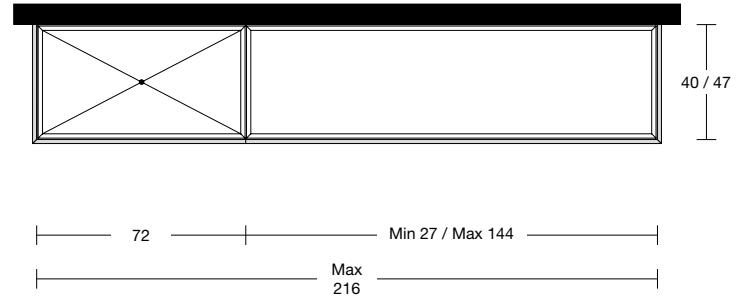
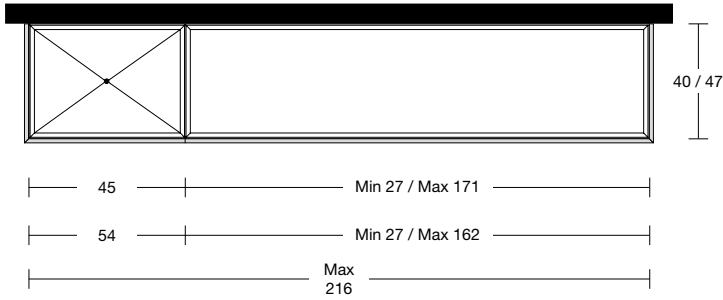

**LAVABO CENTRATO - CENTERED SINK - MITTIGES BECKEN - LAVABO CENTRÉ - LAVABO CENTRADO - РАКОВИНА ПО ЦЕНТРУ**

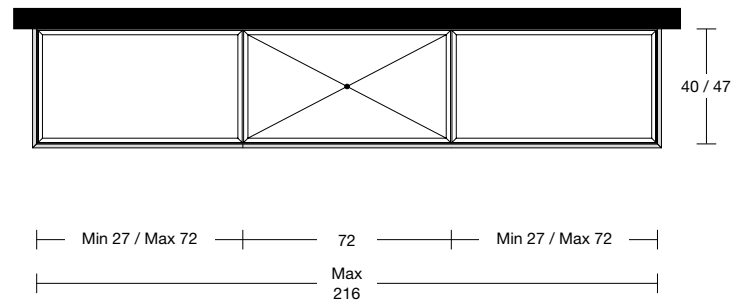
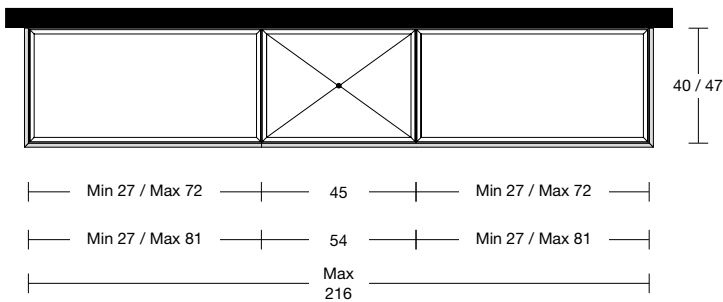

**LAVABO DOPPIO - DOUBLE SINK - DOPPELWASCHBECKEN - DOUBLE VASQUE - LAVABO DOBLE - ДВОЙНАЯ РАКОВИНА**

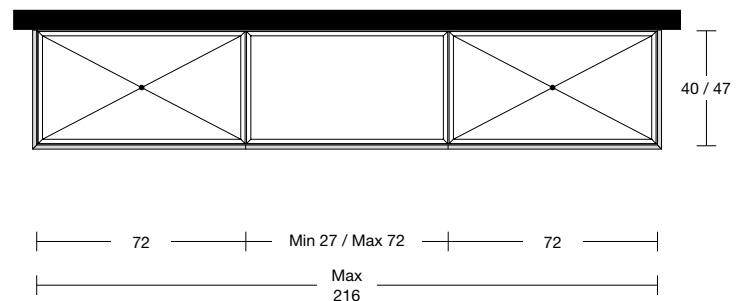
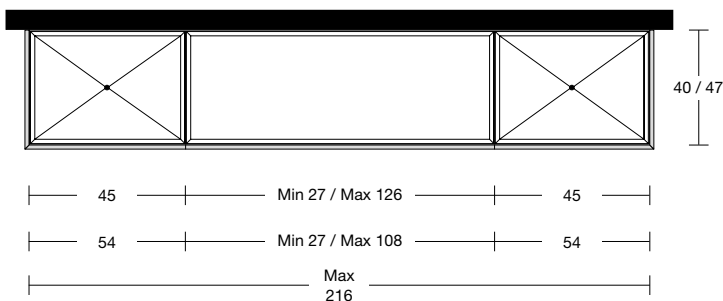

NABATEI

**LAVABO DECENTRATO CON CANALE - OFF-CENTER SINK WITH CANAL - EXZENTRISCHES BECKEN MIT RÜCKKANAL - LAVABO DÉCENTRÉ AVEC CANAL ARRIÈRE - LAVABO DESCENTRADO CON CANAL - ДВОЙНАЯ РАКОВИНА С КАНАЛОМ**

VERSIONE SX - Left version - Version links - Version gauche  
- Versión izquierda - Лев. вариант

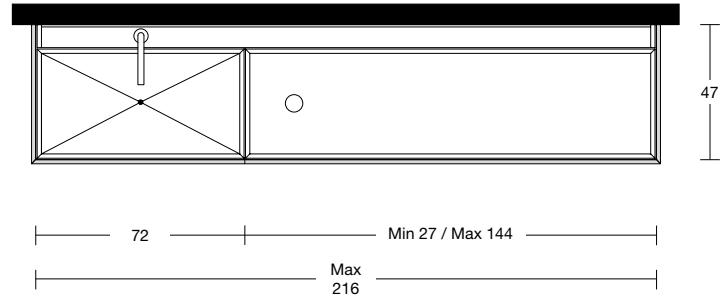
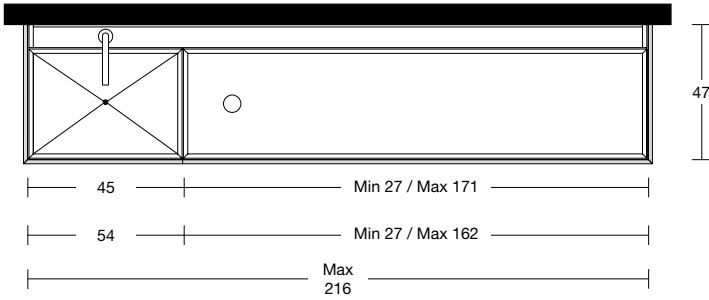

**LAVABO CENTRATO CON CANALE - CENTERED SINK WITH CANAL - MITTIGES BECKEN MIT RÜCKKANAL - LAVABO CENTRÉ AVEC CANAL ARRIÈRE - LAVABO CENTRADO CON CANAL - РАКОВИНА ПО ЦЕНТРУ С КАНАЛОМ**

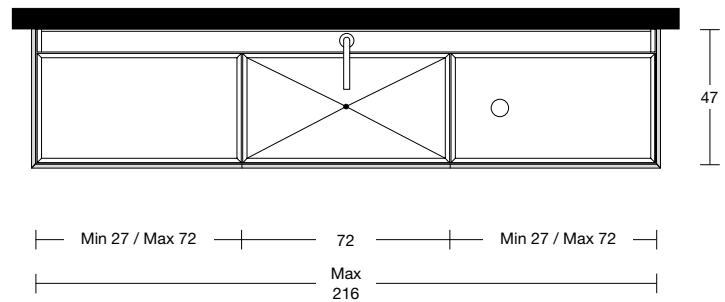
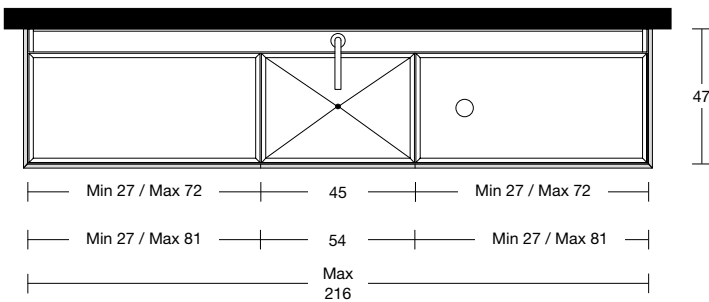

**LAVABO DOPPIO CON CANALE - DOUBLE SINK WITH CANAL - DOPPELWASCHBECKEN MIT RÜCKKANAL - DOUBLE VASQUE AVEC CANAL ARRIÈRE - LAVABO DOBLE CON CANAL - ДВОЙНАЯ РАКОВИНА С КАНАЛОМ**

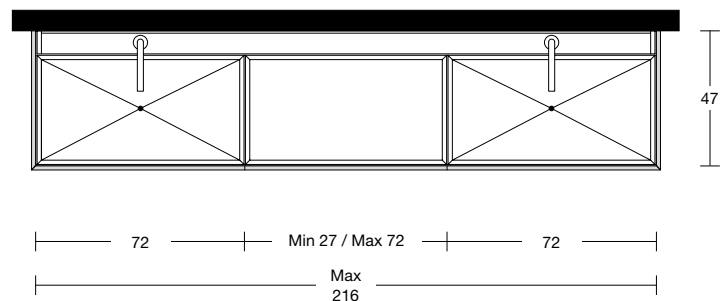
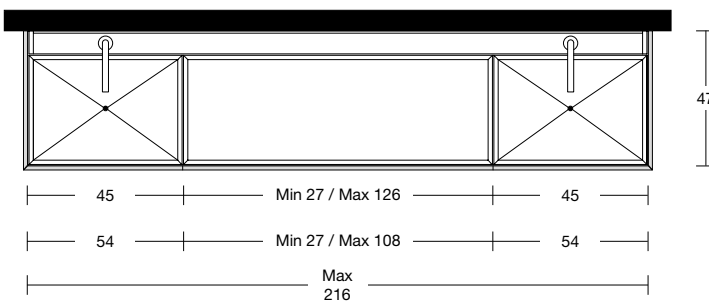

## NABATEI

## TOP INCASSATO - RECESSED TOP - TOP ZUR EINBAUMONTAGE - TOP ENCASTRÉ - ENCIMERA EMPOTRADA - ВСТРОЕННАЯ СТОЛЕШНИЦА

**IT** \_ Top Nabatei incassato, con e senza canale, da abbinare solo alla Collezione Nabatei.

**EN** \_ Nabatei recessed top, with and without canal, to combine only with the Nabatei Collection.

**DE** \_ Top Nabatei zur Einbaumontage, mit oder ohne Rückkanal, nur mit der Kollektion Nabatei zu kombinieren.

**FR** \_ Top Nabatei encastré, avec ou sans canal, uniquement pour la collection Nabatei.

**ES** \_ Encimera Nabatei empotrada, con y sin canal, sólo para combinar con la Colección Nabatei.

**RU** \_ Встроенная столешница Nabatei, с/без канала, совместима только с коллекцией мебели Nabatei.

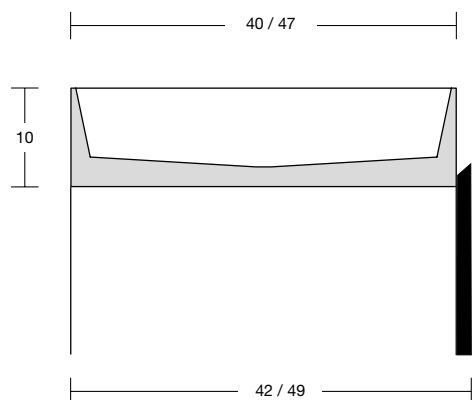

## NABATEI





NABATEI

TOP DA APPOGGIO - COUNTER TOP - TOP ZUR AUFSATZMONTAGE - TOP À POSER - ENCIMERA DE APOYO - НАКЛАДНАЯ СТОЛЕШНИЦА

**IT** \_ Top Nabatei da appoggio, con e senza canale, da abbinare solo alle collezioni:

**EN** \_ Countertop Nabatei tops, with and without canal, to combine only with collections:

**DE** \_ Top Nabatei zur Aufsatzmontage, mit oder ohne Rückkanal, nur mit den Möbelkollektionen zu kombinieren:

**FR** \_ Top Nabatei, avec ou sans canal, uniquement pour les collections:

**ES** \_ Encimera Nabatei de apoyo, con y sin canal, sólo para combinar con las colecciones:

**RU** \_ Накладная столешница Nabatei, с/без канала, совместима только с коллекциями мебели:

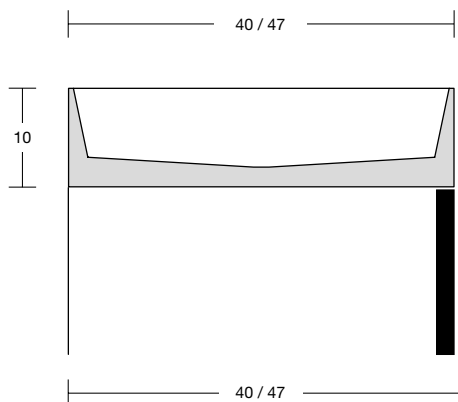

RIQUADRO



BESTREET



BEMADE



BORDERLINE



BESPOKE



NABATEI



mobile / forniture  
ROVERE GRIGIO

NABATEI

IT \_ **Tutta la collezione Nabatei può essere realizzata scegliendo tra le categorie A, D e O.**

EN \_ The entire Nabatei collection can be made by choosing from categories A, D, and O.

DE \_ Die gesamte Nabatei-Kollektion kann durch Auswahl zwischen den Kategorien A, D und O realisiert werden.

FR \_ L'ensemble de la collection Nabatei est disponible dans les catégories A, D et O.

ES \_ Toda la colección Nabatei puede realizarse eligiendo entre las categorías A, D y O.

RU \_ Коллекция Nabatei может быть реализована в категориях A, D и O.

**A**



IT \_ **Bianco lucido/Colorato gofrato**  
 EN \_ Glossy white/Embossed lacquered  
 DE \_ Weiß Hochglanz/farbig gaufriert lackiert  
 FR \_ Blanc brillant/ Laqué gaufré  
 ES \_ Blanco brillo/Colores gofrados  
 RU \_ Белый блестящий/Цветной гофрато.

**D**



IT \_ **Colorato lucido/Colorato seta**  
 EN \_ Glossy lacquered/Silk lacquered  
 DE \_ Glänzend farbig lackiert/Seide farbig lackiert  
 FR \_ Laqué brillant/ Laqué soie  
 ES \_ Colores brillantes/Colores seda  
 RU \_ Цветной блестящий/ Цветной seta

**O**



**Rovere:** sbiancato  
 naturale  
 castano  
 moro  
 grigio  
 matita  
 ardesia  
 thermo  
 evaporato

IT \_ **Essenza legno**  
 EN \_ Wood essence  
 DE \_ Holzessenz  
 FR \_ Essence bois  
 ES \_ Esencia madera  
 RU \_ Шпон натурального  
 дерева

**Noce:** canadese  
 visone  
 canaletto

**Olmo:** moro

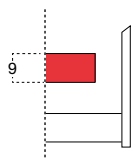

## NABATEI

Art. **SLIM40** P 40/47**IT** \_ Cassetto interno opzionale H 9 cm solo per mobili H 52 cm.**EN** \_ Optional internal drawer H 9 cm only for cabinets H 52 cm.**DE** \_ Optional verwendbare innenliegende Schublade H 9 cm. Nur für Möbel H 52 cm.**FR** \_ Tiroir interne en option H 9 cm uniquement pour meubles H 52 cm.**ES** \_ Cajón interior opcional H 9 cm solo para muebles H 52 cm.**RU** \_ Дополнительный внутренний ящик H 9 см только для мебели H 52 см.**SLIM****P 40/47**

L

27

36

45

54

63

72

90

108

126

## LED\_IN

**IT** \_ Illuminazione a led all'interno di porta lavabi e basi compresa di trasformatore.**EN** \_ Internal led lighting in sink units and cabinets complete with transformer.**DE** \_ Led-Beleuchtung in der internen Seite von WT-Unterschränken und Unterschränken inkl. Transformator.**FR** \_ Éclairage LED interne pour porte-lavabos et meubles bas. Transformateur inclus.**ES** \_ Iluminación led en el interior de soporte lavabos y módulos bajos incl. transformador.**RU** \_ Светодиодная подсветка для тумб под раковины и баз изнутри, трансформатор в комплекте.

ART.

LED\_IN

## BARRALED

**IT** \_ Barra LED compresa di trasformatore per illuminazione sotto porta lavabi e basi.**EN** \_ LED bar complete with transformer for lighting under sink units and cabinets.**DE** \_ LED-Streife inkl. Transformator für Beleuchtung unten WT-Unterschränken und Unterschränken.**FR** \_ Barre de LED avec transformateur pour l'éclairage en-dessous des porte-lavabos et meubles bas.**ES** \_ Tira LED con transformador para iluminación debajo de soporte lavabos y módulos bajos.**RU** \_ Светодиодная планка для подсветки тумб под раковины и баз снизу композиции, трансформатор в комплекте.

da/a - from/to - von/bis - à/et - de/a - от/до

L

27/108

109/198

199/216

## NABATEI

Bianco lucido/Colorato goffrato  
Glossy white/Embossed lacqueredColorato lucido/Colorato seta  
Glossy lacquered/Silk lacqueredEssenza legno  
Wood essence

A

D

O

IT \_ Fianco da aggiungere a dx o sx della composizione, formata da uno o più componenti.

Si consiglia di non utilizzare il fianco per l'installazione in nicchia (A).

EN \_ Side panel to be added to the right or left side of the composition, formed by one or more components.

It is recommended not to use the side panel for installation in the niche (A).

DE \_ Seitenwand, die rechts oder links an der Komposition (bestehend aus einem oder mehreren Teilen) hinzuzufügen ist. Wir empfehlen, die Seitenwand nicht für den Einbau in die Nische (A) zu verwenden.

FR \_ Flanc de finition à ajouter à droite ou gauche de la composition, composée d'un ou plusieurs éléments.

Nous conseillons de ne pas utiliser de flancs lorsque que le meuble est dans une niche (A).

ES \_ Costado lateral terminal para añadir a la der. o a la izq. de la composición, formada por uno o más módulos.

Se aconseja no utilizar el lateral para la instalación entre paredes (A).

RU \_ Боковая панель правая или левая для завершения композиции, состоящей из одного или больше элементов.

Не рекомендуем использовать боковые панели при установке композиции в нишу (A).

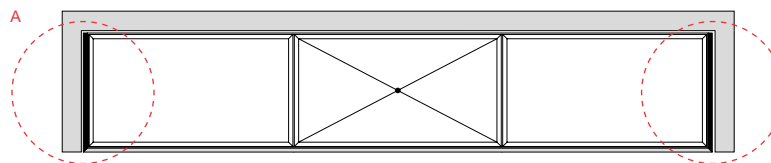
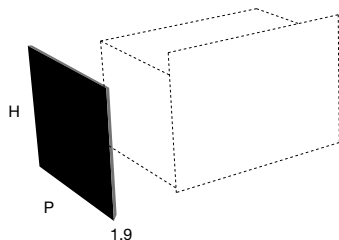

H	P	ART.				
39,5	42	NBFB42				
	49	NBFB49				
52	42	NBFI42				
	49	NBFI49				
82	42	NBFA42				
	49	NBFA49				

IT \_ Compensatore con struttura in Skin cenere e rivestimento in marmo o colorato seta. Prezzo al cm.

N.B: il colorato seta è da utilizzare in abbinamento ai top in Colormood.

EN \_ Compensator with Skin cenere frame and marble or silk lacquered covering. Price per cm.

Note: Silk lacquering is to be considered in combination with Colormood tops.

DE \_ Verbindungsmodul mit Korpus Skin Cenere und Verkleidung aus Marmor oder Seiden lackiert. Preis pro cm.

NB: Die Seidenlackierung ist in Kombination mit Colormood- Tops zu verwenden.

FR \_ Compensateur avec structure en Skin cenere et revêtement en marbre ou laqué soie. Prix au cm.

N.B : Le laquage finition soie doit être utilisé en combinaison avec les tops en Colormood.

ES \_ Compensador con estructura en Skin cenere y revestimiento de mármol o lacado seda. Precio por cm.

N.B: el lacado seda debe utilizarse en combinación con las encimeras de Colormood.

RU \_ Компенсатор со структурой в Skin Cenere и покрытием из мрамора или покраской seta. Цена за см.

Примечание: покраска seta используется только в сочетании со столешницей из материала Colormood.

H 33,5 - 46



P 40 - 47

Bianco Carrara  
Nero Marquina  
Stone Grey  
Bardiglio Nuvolato  
Pietra Luna  
Collemandina

Emperador

Grigio Lavico  
Verde AlpiBianco Silver  
Rosso Levante

Port Laurent

Calacatta Viola

Colorato seta  
Silk lacquered

ART.	L						
NBC21	12,5 / 21,5						
NBC30	21,6 / 30,5						
NBC39	30,6 / 39,5						
NBC48	39,6 / 48,5						
NBC54	48,6 / 54						

NABATEI

Bianco lucido/Colorato goffrato  
Glossy white/Embossed lacquered

Colorato lucido/Colorato seta  
Glossy lacquered/Silk lacquered

Essenza legno  
Wood essence

**A**

**D**

**O**

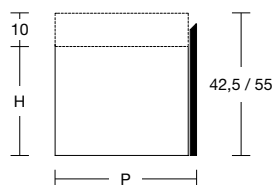

- IT** \_ Porta lavabo terminale dx o sx con 1 cassetto Art. SLIM.  
N.B: da utilizzare con il fianco terminale (A) o con il compensatore (B).
- EN** \_ Right or left sink unit with 1 drawer Art. SLIM.  
Note: to be used with the end side panel (A) or the compensator (B).
- DE** \_ Rechter oder linker Abschluss- WT-Unterschrank mit 1 Schublade Art. SLIM.  
N.B.: zu verwenden mit der Seitenwand (A) oder mit dem Verbindungsmodul (B).
- FR** \_ Porte-lavabo droit ou gauche avec 1 tiroir Art. SLIM.  
N.B. : à utiliser avec le flanc de finition (A) ou le compensateur (B).
- ES** \_ Soporte lavabo terminal der. o izq. con 1 cajón Art. SLIM.  
N.B.: para utilizar con el costado lateral terminal (A) o con el compensador (B).
- RU** \_ Тумба под раковину угловая прав.или лев.стороня с 1 ящиком арт. SLIM.  
Для использования с боковыми панелями (A) или компенсатором (B).

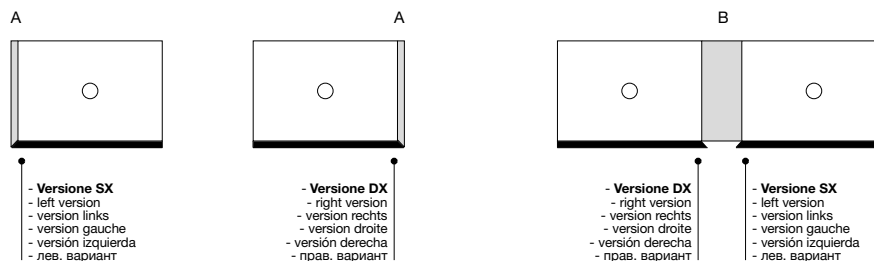
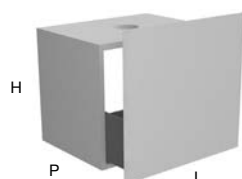

H	P	L	ART.	SLIM H			
32,5	42	54	NBLB154T	18			
		63	NBLB163T	18			
		72	NBLB172T	18			
		90	NBLB190T	18			
		108	NBLB1108T	18			
49	54	54	NBLB254T	18			
		63	NBLB263T	18			
		72	NBLB272T	18			
		90	NBLB290T	18			
		108	NBLB2108T	18			
45	42	54	NBLI154T	18			
		63	NBLI163T	18			
		72	NBLI172T	18			
		90	NBLI190T	18			
		108	NBLI1108T	18			
49	54	54	NBLI254T	18			
		63	NBLI263T	18			
		72	NBLI272T	18			
		90	NBLI290T	18			
		108	NBLI2108T	18			

NABATEI

Bianco lucido/Colorato goffrato  
Glossy white/Embossed lacqueredColorato lucido/Colorato seta  
Glossy lacquered/Silk lacqueredEssenza legno  
Wood essence

A

D

O

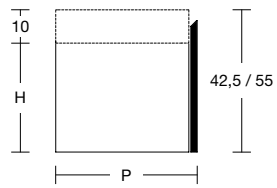

**IT** \_ Porta lavabo con 1 cassetto Art. SLIM. Per soluzione in nicchia o tra 2 moduli.

**EN** \_ Sink unit with 1 drawer Art. SLIM. For solution in niche or between 2 modules.

**DE** \_ WT- Unterschrank mit 1 Schublade Art. SLIM, für Nischenlösung oder zwischen 2 Modulen.

**FR** \_ Porte-lavabo avec 1 tiroir art.SLIM. Pour solution en niche ou entre deux éléments.

**ES** \_ Soporte lavabo con 1 cajón Art. SLIM. Para solución entre paredes o entre 2 módulos.

**RU** \_ Тумба под раковину с 1 ящиком арт. SLIM. Для использования в нишу или между 2-мя модулями.

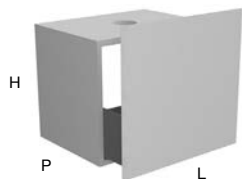

H	P	L	ART.	SLIM H			
32,5	42	54	NBLB154	18			
		63	NBLB163	18			
		72	NBLB172	18			
		90	NBLB190	18			
		108	NBLB1108	18			
49	54	NBLB254	18				
		NBLB263	18				
		NBLB272	18				
		NBLB290	18				
		NBLB2108	18				
45	42	54	NBLI154	18			
		63	NBLI163	18			
		72	NBLI172	18			
		90	NBLI190	18			
		108	NBLI108	18			
49	54	NBLI254	18				
		NBLI263	18				
		NBLI272	18				
		NBLI290	18				
		NBLI2108	18				

NABATEI

Bianco lucido/Colorato goffrato  
Glossy white/Embossed lacquered

Colorato lucido/Colorato seta  
Glossy lacquered/Silk lacquered

Essenza legno  
Wood essence

A

D

O

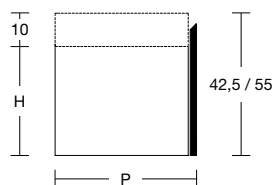

- IT** \_ Porta lavabo per 1 lavabo dx o sx con 1 frontale e 2 cassetti Art. SLIM. Completo di fianchi.
- EN** \_ Sink unit for 1 right or left sink with 1 front and 2 drawers Art. SLIM. Complete with side panel.
- DE** \_ WT-Unterschrank für ein Becken rechtem oder linkem mit 1 Front und 2 Schubladen Art. SLIM. Komplet mit Seitenwand.
- FR** \_ Porte-lavabo pour 1 seul lavabo droite ou à gauche avec 1 façade et 2 tiroirs Art. SLIM. Complet de Flanc de finition.
- ES** \_ Soporte lavabo para un lavabo derecho o izquierdo con 1 frontal y 2 cajones Art. SLIM. Con costado lateral terminal incluido.
- RU** \_ Тумба на 1 раковину с 1 передней правосторонним или левосторонним панелью и 2 ящиками арт. SLIM. в комплекте с боковыми панелями.

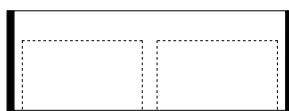
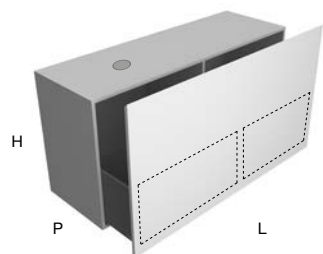

H	P	L	ART.	SLIM H			
32,5	42	112	NBLB1108TT	18			
		148	NBLB1144TT	18			
49	42	112	NBLB2108TT	18			
		148	NBLB2144TT	18			
45	42	112	NBLI1108TT	18			
		148	NBLI1144TT	18			
49	42	112	NBLI2108TT	18			
		148	NBLI2144TT	18			

VERSIONE SX - Left version - Version links  
Version gauche - Versión izquierda - лев. вариант



**Divisioni top** - Top dividers - Topaufteilung  
- Divisions du top - Particiones encimera -  
Разделители столешницы:

54 + 54 = 108

72 + 72 = 144

54 + 36 + 54 = 144



NABATEI

Bianco lucido/Colorato goffrato  
Glossy white/Embossed lacquered

Colorato lucido/Colorato seta  
Glossy lacquered/Silk lacquered

Essenza legno  
Wood essence

A

D

O

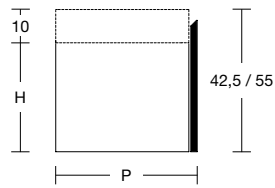

IT \_ Porta lavabo per 2 lavabi con 1 frontale e 2 cassetti Art. SLIM. Completo di fianchi.

EN \_ Sink unit for 2 sinks with 1 front and 2 drawers Art. SLIM. Complete with side panel.

DE \_ WT-Unterschrank für zwei Becken mit 1 Front und 2 Schubladen Art. SLIM. Komplett mit Seitenwand.

FR \_ Porte-lavabo pour 2 lavabo avec 1 façade et 2 tiroirs Art. SLIM. Complet de Flanc de finition.

ES \_ Soporte lavabo para 2 lavabos con 1 frontal y 2 cajones Art. SLIM. Con costado lateral terminal incluido.

RU \_ Тумба на 2 раковины с 1 передней панелью и 2 ящиками арт. SLIM. в комплекте с боковыми панелями

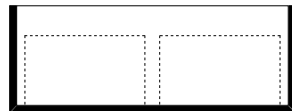
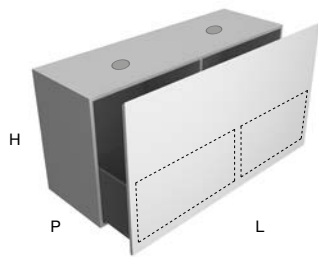

H	P	L	ART.	SLIM H			
32,5	42	112	NBLB10108TT	18			
		148	NBLB10144TT	18			
49	42	112	NBLB20108TT	18			
		148	NBLB20144TT	18			
45	42	112	NBLI10108TT	18			
		148	NBLI10144TT	18			
49	42	112	NBLI20108TT	18			
		148	NBLI20144TT	18			



Divisioni top - Top dividers - Topaufteilung  
- Divisions du top - Particiones encimera -  
Разделители столешницы:

54 + 54 = 108

72 + 72 = 144

54 + 36 + 54 = 144

NABATEI

Bianco lucido/Colorato goffrato  
Glossy white/Embossed lacquered

Colorato lucido/Colorato seta  
Glossy lacquered/Silk lacquered

Essenza legno  
Wood essence

**A**

**D**

**O**

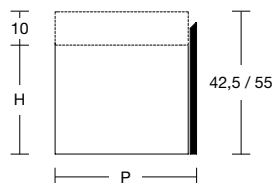

- IT** \_ Base terminale dx o sx con 1 cassetto Art. SLIM.  
N.B.: da utilizzare con il fianco terminale (A) o con il compensatore (B).
- EN** \_ Right or left end cabinet with 1 drawer Art. SLIM.  
Note: to be used with the end side (A) or compensator (B).
- DE** \_ Rechter oder linker Abschluss- Unterschrank mit 1 Schublade Art. SLIM.  
N.B.: zu verwenden mit der Seitenwand (A) oder mit dem Verbindungsmodul (B).
- FR** \_ Meuble bas droit ou gauche avec 1 tiroir art. SLIM.  
N.B.: à utiliser avec le flanc de finition (A) ou le compensateur (B).
- ES** \_ Módulo bajo terminal der. o izq. con 1 cajón Art. SLIM.  
N.B.: para utilizar con el costado lateral terminal (A) o con el compensador (B).
- RU** \_ База угловия прав.или лев.стороня с 1 ящиком арт. SLIM.  
Для использования с боковыми панелями (A) или компенсатором (B).

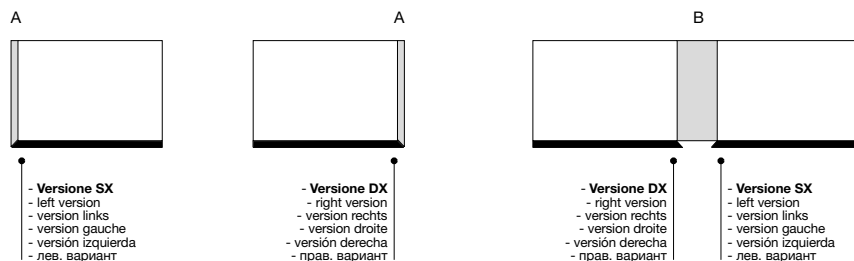
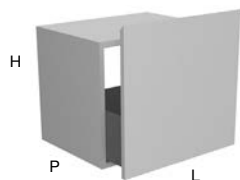

H	P	L	ART.	SLIM H			
32,5	42	54	NBLB154T	18			
		63	NBLB163T	18			
		72	NBLB172T	18			
		90	NBLB190T	18			
		108	NBLB1108T	18			
49	54	54	NBLB254T	18			
		63	NBLB263T	18			
		72	NBLB272T	18			
		90	NBLB290T	18			
		108	NBLB2108T	18			
45	42	54	NBLI154T	18			
		63	NBLI163T	18			
		72	NBLI172T	18			
		90	NBLI190T	18			
		108	NBLI1108T	18			
49	54	54	NBLI254T	18			
		63	NBLI263T	18			
		72	NBLI272T	18			
		90	NBLI290T	18			
		108	NBLI2108T	18			

## NABATEI

Bianco lucido/Colorato goffrato  
Glossy white/Embossed lacqueredColorato lucido/Colorato seta  
Glossy lacquered/Silk lacqueredEssenza legno  
Wood essence

A

D

O

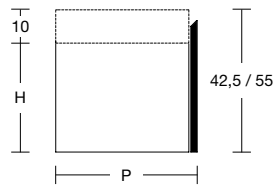

**IT** \_ Base con 1 cassetto Art. SLIM per soluzione in nicchia o tra 2 moduli.

**EN** \_ Cabinet with 1 drawer Art. SLIM for solution in niche or between 2 modules.

**DE** \_ Unterschrank mit 1 Schublade Art. SLIM, für Nischenlösung oder zwischen 2 Modulen.

**FR** \_ Meuble bas avec 1 tiroir art.SLIM. Pour solution en niche ou entre deux éléments.

**ES** \_ Módulo bajo con 1 cajón Art. SLIM para solución entre paredes o entre 2 módulos.

**RU** \_ База с 1 ящиком арт. SLIM. Для использования в нишу или между 2-мя модулями.

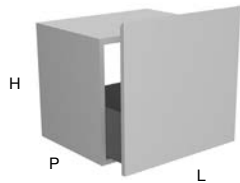

H	P	L	ART.	SLIM H			
32,5	42	27	NBBB127	18			
		36	NBBB136	18			
		45	NBBB145	18			
		54	NBBB154	18			
		63	NBBB163	18			
		72	NBBB172	18			
		90	NBBB190	18			
		108	NBBB1108	18			
		126	NBBB1126	18			
		49	27	27	NBBB227	18	
36	NBBB236			18			
45	NBBB245			18			
54	NBBB254			18			
63	NBBB263			18			
72	NBBB272			18			
90	NBBB290			18			
108	NBBB2108			18			
126	NBBB2126			18			
45	42			27	NBBI127	18	
		36	NBBI136	18			
		45	NBBI145	18			
		54	NBBI154	18			
		63	NBBI163	18			
		72	NBBI172	18			
		90	NBBI190	18			
		108	NBBI1108	18			
		126	NBBI1126	18			
		49	27	27	NBBI227	18	
36	NBBI236			18			
45	NBBI245			18			
54	NBBI254			18			
63	NBBI263			18			
72	NBBI272			18			
90	NBBI290			18			
108	NBBI2108			18			
126	NBBI2126			18			

NABATEI

Bianco lucido/Colorato goffrato  
Glossy white/Embossed lacquered

Colorato lucido/Colorato seta  
Glossy lacquered/Silk lacquered

Essenza legno  
Wood essence

**A**

**D**

**O**

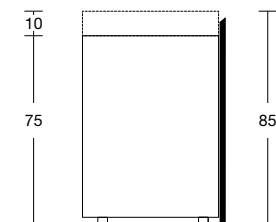

**IT** \_ Porta lavabo terminale dx o sx con 3 cassetti interni Art. SLIM.

**N.B: da utilizzare con il fianco terminale.**

**EN** \_ Right or left end sink unit with 3 internal drawers Art. SLIM.

Note: to be used with the terminal side panel.

**DE** \_ Rechter oder linker Abschluss- WT-Unterschrank mit 3 innenliegenden Schubladen Art. SLIM.

AV: zu verwenden mit der Seitenwand.

**FR** \_ Porte-lavabo final droit ou gauche avec 3 tiroirs internes Art. SLIM.

NB : à utiliser avec le flanc de finition terminal.

**ES** \_ Soporte lavabo terminal der. o izq. con 3 cajones interiores Art. SLIM.

N.B: para ser utilizado con el costado terminal.

**RU** \_ Тумба под раковину угловая, прав. или лев.сторонняя с 3 ящиками арт. SLIM.

Примечание: необходимо использовать с угловой боковиной.

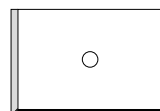
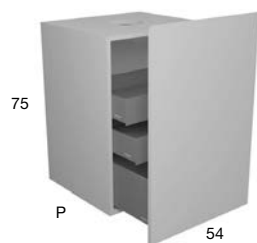

- Versione SX
- left version
- version links
- version gauche
- versión izquierda
- лев. вариант

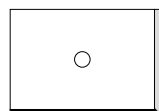

- Versione DX
- right version
- version rechts
- version droite
- versión derecha
- прав. вариант

H	P	L	ART.	SLIM H
75	42	54	NBLA454T	9-18
49		54	NBLA554T	9-18

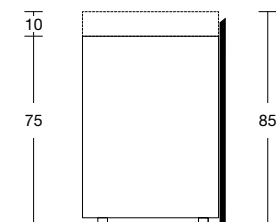

**IT** \_ Porta lavabo con 3 cassetti interni Art. SLIM. Per soluzione in nicchia o tra 2 moduli.

**EN** \_ Sink unit with 3 internal drawers Art. SLIM. For solution in niche or between 2 modules.

**DE** \_ WT- Unterschrank mit 3 innenliegenden Schubladen Art. SLIM, für Nischenlösung oder zwischen 2 Modulen.

**FR** \_ Porte-lavabo avec 3 tiroirs internes art.SLIM. Pour solution en niche ou entre deux éléments.

**ES** \_ Soporte lavabo con 3 cajones interiores Art. SLIM. Para solución entre paredes o entre 2 módulos.

**RU** \_ Тумба под раковину с 3 ящиками арт. SLIM. Для использования в нише или между 2-мя модулями.

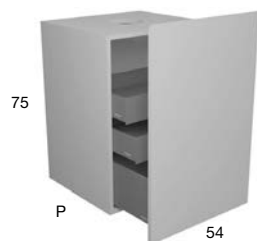

H	P	L	ART.	SLIM H
75	42	54	NBLA454	9-18
49		54	NBLA554	9-18

NABATEI

Bianco lucido/Colorato goffrato  
Glossy white/Embossed lacquered

Colorato lucido/Colorato seta  
Glossy lacquered/Silk lacquered

Essenza legno  
Wood essence

A

D

O

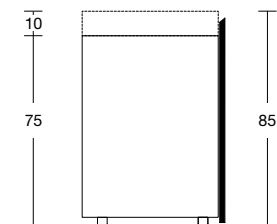

**IT** \_ Porta lavabo terminale dx o sx con 2 ante e 1 ripiano interno.

**N.B:** da utilizzare con il fianco terminale.

**EN** \_ Right or left end sink unit with 2 doors and 1 interior shelf.

Note: to be used with the terminal side panel.

**DE** \_ Rechter oder linker Abschluss- WT-Unterschrank mit 2 Türen und 1 Einlegeboden.

AV: zu verwenden mit der Seitenwand.

**FR** \_ Porte-lavabo final droit ou gauche avec 2 portes et 1 étagère interne

N.B. : à utiliser avec le flanc de finition terminal.

**ES** \_ Soporte lavabo terminal der. o izq. con 2 puertas y 1 estante interior.

N.B: para ser utilizado con el costado terminal.

**RU** \_ Тумба под раковину с 2 дверцами и 1 внутренней полкой. Примечание: необходимо использовать с угловой боковиной.

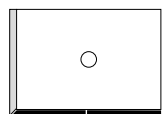
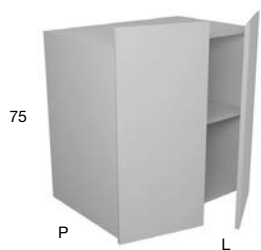

- Versione SX  
- left version  
- version links  
- version gauche  
- versión izquierda  
- лев. вариант

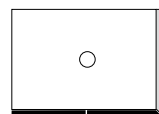

- Versione DX  
- right version  
- version rechts  
- version droite  
- versión derecha  
- прав. вариант

H	P	L	ART.
75	42	54	NBLA5454T
		72	NBLA5472T
49	54	54	NBLA5554T
		72	NBLA5572T

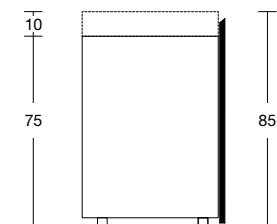

**IT** \_ Porta lavabo con 2 ante e 1 ripiano interno. Per soluzione in nicchia o tra 2 moduli.

**EN** \_ Sink unit with 2 doors and 1 interior shelf. For solution in niche or between 2 modules.

**DE** \_ WT- Unterschrank mit 2 Türen und 1 Einlegeboden, für Nischenlösung oder zwischen 2 Modulen.

**FR** \_ Porte-lavabo avec 2 portes et 1 étagère interne. Pour solution en niche ou entre deux éléments.

**ES** \_ Soporte lavabo con 2 puertas y 1 estante interior. Para solución entre paredes o entre 2 módulos.

**RU** \_ Тумба под раковину с 2 дверцами и 1 внутренней полкой. Для использования в нише или между 2-мя модулями.

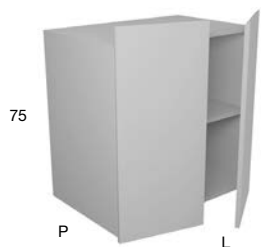

H	P	L	ART.
75	42	54	NBLA5454
		72	NBLA5472
49	54	54	NBLA5554
		72	NBLA5572

NABATEI

Bianco lucido/Colorato goffrato  
Glossy white/Embossed lacquered

Colorato lucido/Colorato seta  
Glossy lacquered/Silk lacquered

Essenza legno  
Wood essence

A

D

O

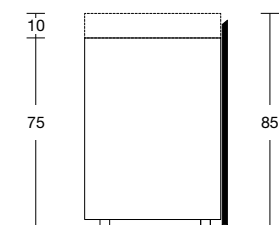

**IT** \_ Base terminale dx o sx con 4 cassetti interni Art. SLIM.

**N.B:** da utilizzare con il fianco terminale.

**EN** \_ Right or left end cabinet with 4 internal drawers Art. SLIM.

Note: to be used with the terminal side panel.

**DE** \_ Rechter oder linker Abschluss- Unterschrank mit 4 innenliegenden Schubladen Art. SLIM.

AV: zu verwenden mit der Seitenwand.

**FR** \_ Meuble bas final droit ou gauche avec 4 tiroirs interne art. SLIM.

N.B. : à utiliser avec le flanc de finition terminal.

**ES** \_ Módulo terminal der. o izq. con 4 cajones interiores Art. SLIM.

N.B: para ser utilizado con el costado terminal.

**RU** \_ База угловая, прав. или лев.сторонняя с 4 ящиками арт. SLIM.

Примечание: необходимо использовать с угловой боковиной.

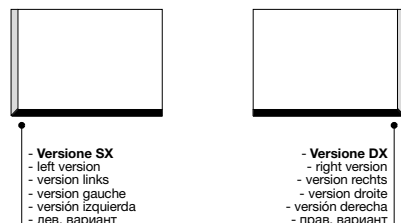
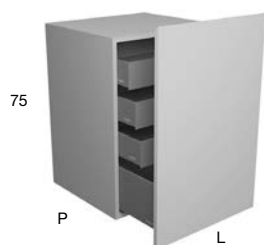

- Versione SX  
- left version  
- version links  
- version gauche  
- versión izquierda  
- лев. вариант

- Versione DX  
- right version  
- version rechts  
- version droite  
- versión derecha  
- прав. вариант

H	P	L	ART.	SLIM H			
75	42	27	NBBA727T	9-18			
		36	NBBA736T	9-18			
		45	NBBA745T	9-18			
		54	NBBA754T	9-18			
49	27	36	NBBA827T	9-18			
		36	NBBA836T	9-18			
		45	NBBA845T	9-18			
		54	NBBA854T	9-18			

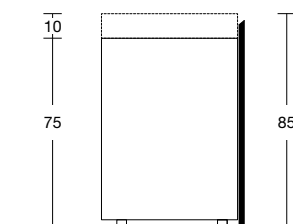

**IT** \_ Base con 4 cassetti interni Art. SLIM per soluzione in nicchia o tra 2 moduli.

**EN** \_ Cabinet with 4 internal drawers Art. SLIM for solution in niche or between 2 modules.

**DE** \_ Unterschrank mit 4 innenliegenden Schubladen Art. SLIM, für Nischenlösung oder zwischen 2 Modulen.

**FR** \_ Meuble bas avec 4 tiroirs internes art.SLIM. Pour solution en niche ou entre deux éléments.

**ES** \_ Módulo con 4 cajones interiores Art. SLIM para solución entre paredes o entre 2 módulos.

**RU** \_ База с 4 ящиками арт. SLIM. Для использования в нише или между 2-мя модулями.

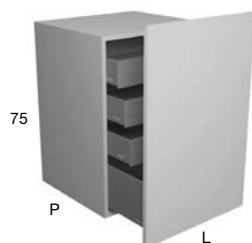

H	P	L	ART.	SLIM H			
75	42	27	NBBA727	9-18			
		36	NBBA736	9-18			
		45	NBBA745	9-18			
		54	NBBA754	9-18			
49	27	36	NBBA827	9-18			
		36	NBBA836	9-18			
		45	NBBA845	9-18			
		54	NBBA854	9-18			

NABATEI

Bianco lucido/Colorato goffrato  
Glossy white/Embossed lacquered

Colorato lucido/Colorato seta  
Glossy lacquered/Silk lacquered

Essenza legno  
Wood essence

A

D

O

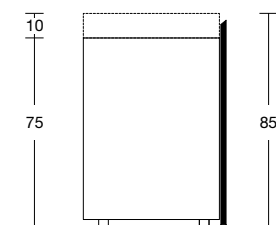

IT \_ Base terminale dx o sx con 1 anta e 2 ripiani interni.

N.B: da utilizzare con il fianco terminale.

EN \_ Right or left end cabinet with 1 door and 2 interior shelves.

Note: to be used with the terminal side panel.

DE \_ Rechter oder linker Abschluss- Unterschrank mit 1 Tür und 2 Einlegeböden.

AV: zu verwenden mit der Seitenwand.

FR \_ Meuble bas final droit ou gauche avec 1 porte e 2 étagères internes.

N.B. : à utiliser avec le flanc de finition terminal.

ES \_ Módulo terminal der. o izq. con 1 puerta y 2 estantes interiores.

N.B: para ser utilizado con el costado terminal.

RU \_ База угловая прав.или лев.сторонняя с 1 дверцей и 2 внутренними полками.

Примечание: необходимо использовать с угловой боковиной.

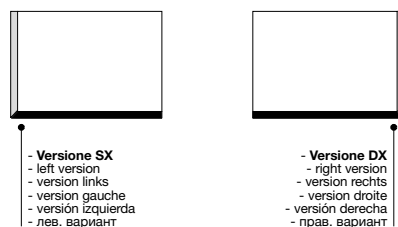
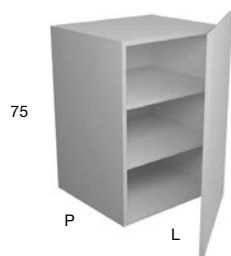

- Versione SX  
- left version  
- version links  
- version gauche  
- versión izquierda  
- лев. вариант

- Versione DX  
- right version  
- version rechts  
- version droite  
- versión derecha  
- прав. вариант

H	P	L	ART.			
75	42	27	NBBA5127T			
		36	NBBA5136T			
		45	NBBA5145T			
		54	NBBA5154T			
49	27	NBBA5227T				
		36	NBBA5236T			
		45	NBBA5245T			
		54	NBBA5254T			

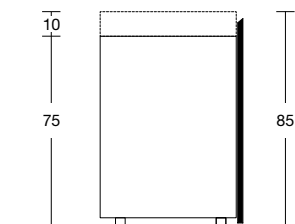

IT \_ Base con 1 anta dx o sx con e 2 ripiani interni. Per soluzione in nicchia o tra 2 moduli.

EN \_ Right or left cabinet with 1 door and 2 interior shelves. for solution in niche or between 2 modules.

DE \_ Unterschrank mit einer rechten oder linken Tür und 2 Einlegeböden, für Nischenlösung oder zwischen 2 Modulen.

FR \_ Meuble bas avec 1 porte droite ou gauche et 2 étagères interne. Pour solution en niche ou entre deux éléments.

ES \_ Módulo con 1 puerta der. o izq. y 2 estantes interiores. Para solución entre paredes o entre 2 módulos.

RU \_ База с 1 дверцей и 2 внутренними полками. Для использования в нише или между 2-мя модулями.

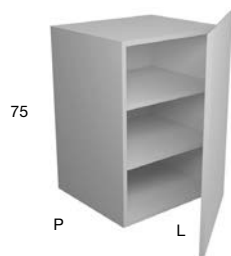

H	P	L	ART.			
75	42	27	NBBA5127			
		36	NBBA5136			
		45	NBBA5145			
		54	NBBA5154			
49	27	NBBA5227				
		36	NBBA5236			
		45	NBBA5245			
		54	NBBA5254			

NABATEI

Bianco lucido/Colorato goffrato  
Glossy white/Embossed lacquered

Colorato lucido/Colorato seta  
Glossy lacquered/Silk lacquered

Essenza legno  
Wood essence

A

D

O

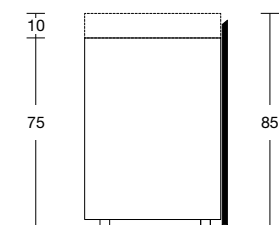

**IT** \_ Base terminale dx o sx con 2 ante e 2 ripiani interni.

**N.B:** da utilizzare con il fianco terminale.

**EN** \_ Right or left end cabinet with 2 doors and 2 interior shelves.

Note: to be used with the end side.

**DE** \_ Rechter oder linker Abschluss- Unterschrank mit 2 Türen und 2 Einlegeböden.

AV: zu verwenden mit der Seitenwand.

**FR** \_ Meuble bas final droit ou gauche avec 2 portes et 2 étagères internes.

N.B. : à utiliser avec le flanc de finition terminal.

**ES** \_ Módulo terminal der. o izq. con 2 puertas y 2 estantes interiores.

N.B: para ser utilizado con el costado terminal.

**RU** \_ База угловая, прав. или лев.сторонняя с 2 дверцами и 2 внутренними полками.

Примечание: необходимо использовать с угловой боковиной.

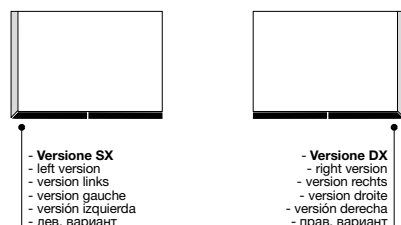
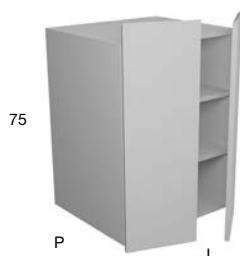

- Versione SX  
- left version  
- version links  
- version gauche  
- versión izquierda  
- лев. вариант

- Versione DX  
- right version  
- version rechts  
- version droite  
- versión derecha  
- прав. вариант

H	P	L	ART.
75	42	54	NBBA5454T
		72	NBBA5472T
		90	NBBA5490T
		108	NBBA54108T
49	54	54	NBBA5554T
		72	NBBA5572T
		90	NBBA5590T
		108	NBBA55108T

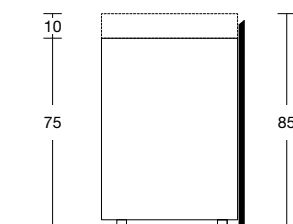

**IT** \_ Base con 2 ante e 2 ripiani interni. Per soluzione in nicchia o tra 2 moduli.

**EN** \_ Cabinet with 2 doors and 2 interior shelves. for solution in niche or between 2 modules.

**DE** \_ Unterschrank mit 2 Türen und 2 Einlegeböden, für Nischenlösung oder zwischen 2 Modulen.

**FR** \_ Meuble bas avec 2 portes et 2 étagères interne. Pour solution en niche ou entre deux éléments.

**ES** \_ Módulo con 2 puertas y 2 estantes interiores. Para solución entre paredes o entre 2 módulos.

**RU** \_ База с 2 дверцами и 2 внутренними полками. Для использования в нише или между 2-мя модулями.

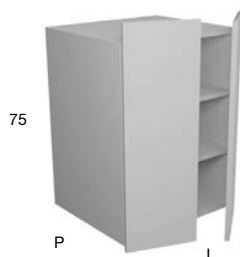

H	P	L	ART.
75	42	54	NBBA5454
		72	NBBA5472
		90	NBBA5490
		108	NBBA54108
49	54	54	NBBA5554
		72	NBBA5572
		90	NBBA5590
		108	NBBA55108





materiali  
e finiture /  
materials  
and finishes

**MARMO | PIETRA - MARBLE | STONE**



Bianco Carrara



Nero Marquina



Verde Alpi

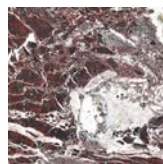

Rosso Levanto

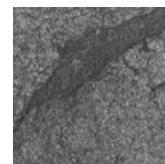

Stone Grey

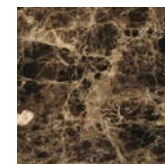

Emperador

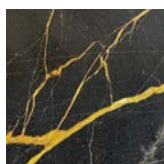

Port Laurent



Pietra Luna

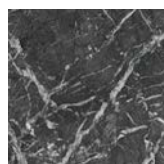

Grigio Lavico

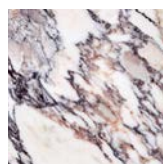

Calacatta Viola



Bardiglio Nuvolato

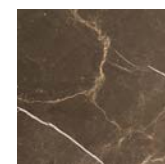

Collemandina

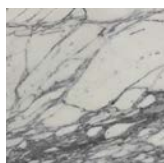

Bianco Silver

**ESSENZE LEGNO - WOOD ESSENCE**

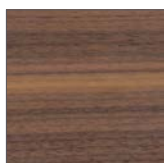

Noce canadese

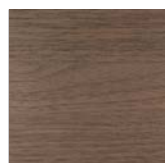

Noce visone

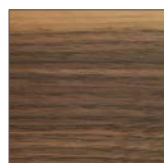

Noce canaletto

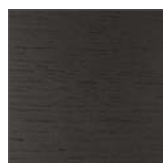

Rovere ardesia

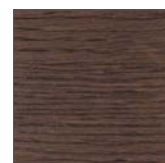

Rovere castano

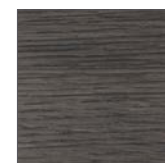

Rovere grigio

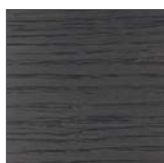

Rovere matita



Rovere naturale

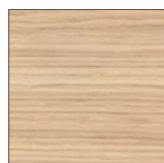

Rovere sbiancato

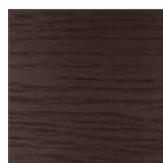

Rovere moro



Rovere evaporato



Rovere thermo



Olmo moro

LACCATI LUCIDI, GOFFRATI, SETA E COLORMOOD - GLOSSY LACQUERED EMBOSSED, SILK AND COLORMOOD

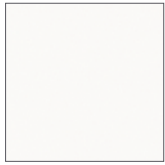

Bianco



Bianco mood



Bianco vetro



Ovatta



Meringa

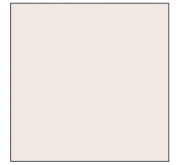

Biancospino

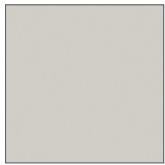

Cemento



Serena



Grigio smog



Malta



Lichene



Creta

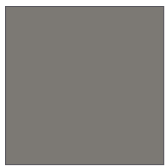

Delfino

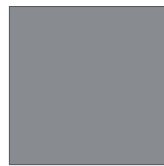

Iceberg

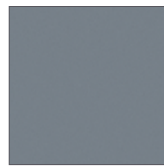

Grigio pioggia



Grigio piombo



Ramerino



Matita



Basalto



Nero



Skin cenere



Malva

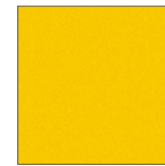

Mostarda

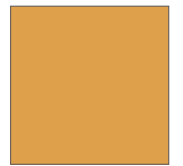

Coccodrillo



Cipria



Bambola



Veneziano



Terracotta



Pompeiano



Geranio



Melograno



Mirto



Vino



Pomice



Lambretta



Vespa



Flora



Alga



Anatra



Ossido



Era glaciale



Cielo



Mirtillo



Rana blu



Catalina



Blu navy



Strada



Profondo blu

LACCATI LUCIDI, GOFFRATI, SETA E COLORMOOD - GLOSSY LACQUERED EMBOSSED, SILK AND COLORMOOD

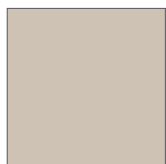

Falena



Tortora

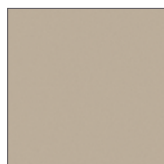

Havana



Mamba



Argilla



Grigio vesuvio



Smoke



Corteccia



Kajal

**www.antoniolupi.it**

Per essere costantemente informati su novità e prodotti in modo dettagliato, vi invitiamo a navigare nel nostro sito sempre aggiornato.

Nell'area download potrete scaricare tutto il materiale tecnico ed informativo che vi necessita.

*To constantly be up to date in a detailed manner on novelties and products please navigate through our website.  
In the download area you can find all the necessary technical information.*

**NOTA**

Alla Antonio Lupi Design S.p.A. è riservata la facoltà di apportare ai propri modelli qualsiasi modifica estetica, tecnica, nelle dimensioni e nei colori, ritenuta necessaria, nonché la facoltà di sospendere la produzione in qualunque momento senza preavviso, rinunziata fin d'ora da parte del committente ogni conseguente richiesta risarcitoria.

Si declina ogni responsabilità relativa ad eventuali inesattezze contenute in questo catalogo, se dovute ad errori di stampa o trascrizioni.

Nessun contenuto di questo catalogo può essere copiato, riprodotto anche parzialmente, ripubblicato, trasmesso o distribuito in qualunque forma, senza autorizzazione scritta dell'Antonio Lupi Design S.p.a.

**NOTE**

*Antonio Lupi Design S.p.A. reserves the right to make any and all necessary aesthetic, technical, colour or size modifications in order to enhance use and aesthetic value, and may suspend the production cycle at any moment without notice. Such instances may not be subject to claim by the client.*

*We decline all responsibilities for any possible uncertainties due to misprints in this catalogue.*

*None of the material in this catalogue can be copied, reproduced, republished or distributed in any or partial way unless a written authorization is given from the company Antonio Lupi Design S.p.a.*



Prodotto interamente in Italia  
*Entirely made in Italy*

©Antonio Lupi Design S.p.A. 2025